

User's Manual

FlexScan[®] S2100-M

Color LCD Monitor

Important

Please read this User's Manual and Setup Manual (separate volume) carefully to familiarize yourself with safe and effective usage.

PRECAUTIONS

Chapter 1 Features and Overview

- 1-1 Features
- 1-2 Buttons and Indicators
- 1-3 Functions and Basic Operation

Chapter 2 Settings and Adjustments

- 2-1 Utility Disk
- 2-2 Screen Adjustment
- 2-3 Color Adjustment
- 2-4 Off Timer Settings
- 2-5 Screen Size Selection
- 2-6 Power Indicator/EIZO Logo Display Setting
- 2-7 Locking Buttons
- 2-8 Setting Adjustment menu Display
- 2-9 Viewing Information/Setting Language
- 2-10 Setting BrightRegulator
- 2-11 Resumption of Default Setting

Chapter 3 Connecting Cables

- 3-1 Connecting Two PCs to the Monitor
- 3-2 Connecting Peripheral USB Devices

Chapter 4 Troubleshooting

Chapter 5 Reference

- 5-1 Attaching an Arm (Option)
- 5-2 Cleaning
- 5-3 Specifications
- 5-4 Glossary
- 5-5 Preset Timing





How to Setup

Please read the Setup Manual (separate volume)



SAFETY SYMBOLS

This manual uses the safety symbols below. They denote critical information. Please read them carefully.

 <p>WARNING Failure to abide by the information in a WARNING may result in serious injury and can be life threatening.</p>	 <p>CAUTION Failure to abide by the information in a CAUTION may result in moderate injury and/or property or product damage.</p>
	<p>Indicates a prohibited action.</p>
	<p>Indicates to ground for safety.</p>

Copyright© 2005 EIZO NANA O CORPORATION All rights reserved.

No part of this manual may be reproduced, stored in a retrieval system, or transmitted, in any form or by any means, electronic, mechanical, or otherwise, without the prior written permission of EIZO NANA O CORPORATION. EIZO NANA O CORPORATION is under no obligation to hold any submitted material or information confidential unless prior arrangements are made pursuant to EIZO NANA O CORPORATION's receipt of said information. Although every effort has been made to ensure that this manual provides up-to-date information, please note that EIZO monitor specifications are subject to change without notice.

ENERGY STAR is a U.S. registered mark.
 Apple and Macintosh are registered trademarks of Apple Computer, Inc.
 VGA is a registered trademark of International Business Machines Corporation.
 DPMS is a trademark and VESA is a registered trademark of Video Electronics Standards Association.
 Windows is a registered trademark of Microsoft Corporation.
 PowerManager is a trademark of EIZO NANA O CORPORATION.
 FlexScan, ScreenManager and EIZO are registered trademarks of EIZO NANA O CORPORATION.

<p>As an ENERGY STAR® Partner, EIZO NANA O CORPORATION has determined that this product meets the ENERGY STAR guidelines for energy efficiency.</p>	
---	---

<p>Product specification may vary with sales areas. Confirm the specification in the manual written in language of the region of purchase.</p>

PRECAUTIONS

IMPORTANT

- This product has been adjusted specifically for use in the region to which it was originally shipped. If the product is used outside the region, it may not operate as specified in the specifications.
- To ensure personal safety and proper maintenance, please read carefully this section and the caution statements on the monitor.

[Location of Caution Statement]

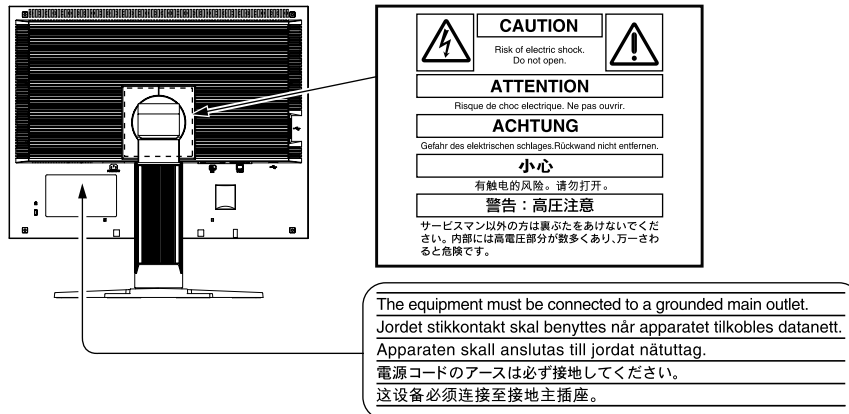

WARNING

If the unit begins to emit smoke, smells like something is burning, or makes strange noises, disconnect all power connections immediately and contact your dealer for advice.

Attempting to use a malfunctioning unit may result in fire, electric shock, or equipment damage.

Do not open the cabinet or modify the unit.

Opening the cabinet or modifying the unit may result in fire, electric shock, or burn.



Refer all servicing to qualified service personnel.

Do not attempt to service this product yourself as opening or removing covers may result in fire, electric shock, or equipment damage.

Keep small objects or liquids away from the unit.

Small objects accidentally falling through the ventilation slots into the cabinet or spillage into the cabinet may result in fire, electric shock, or equipment damage.

If an object or liquid falls/spills into the cabinet, unplug the unit immediately. Have the unit checked by a qualified service engineer before using it again.



WARNING

Place the unit at the strong and stable place.

A unit placed on an inadequate surface may fall and result in injury or equipment damage. If the unit falls, disconnect the power immediately and ask your dealer for advice. Do not continue using a damaged unit. Using a damaged unit may result in fire or electric shock.

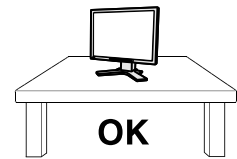

Set the unit in an appropriate location.

Not doing so may result in fire, electric shock, or equipment damage.

- Do not place outdoors.
- Do not place in the transportation system (ship, aircraft, trains, automobiles, etc.)
- Do not place in a dusty or humid environment.
- Do not place in a location where the steam comes directly on the screen.
- Do not place near heat generating devices or a humidifier.

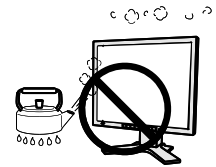

To avoid danger of suffocation, keep the plastic packing bags away from babies and children.

Use the enclosed power cord and connect to the standard power outlet of your country.

Be sure to remain within the rated voltage of the power cord.

Not doing so may result in fire or electric shock.

To disconnect the power cord, grasp the plug firmly and pull.

Tugging on the cord may damage and result in fire or electric shock.



The equipment must be connected to a grounded main outlet.

Failure to do so may result in fire or electric shock.



Use the correct voltage.

- The unit is designed for use with a specific voltage only. Connection to another voltage than specified in this User's Manual may cause fire, electric shock, or equipment damage.
 - Do not overload your power circuit, as this may result in fire or electric shock.
-

WARNING

Handle the power cord with care.

- Do not place the cord underneath the unit or other heavy objects.
- Do not pull on or tie the cord.

If the power cord becomes damaged, stop using it. Use of a damaged cord may result in fire or electric shock.



Never touch the plug and power cord if it begins to thunder.

Touching them may result in electric shock.

When attaching an arm stand, please refer to the user's manual of the arm stand and install the unit securely with the enclosed screws.

Not doing so may cause the unit to become unattached, which may result in injury or equipment damage. When the unit is dropped, please ask your dealer for advice. Do not continue using a damaged unit. Using a damaged unit may result in fire or electric shock. When reattaching the tilt stand, please use the same screws and tighten them securely.

Do not touch a damaged LCD panel directly with bare hands.

The liquid crystal that may leak from the panel is poisonous if it enters the eyes or mouth. If any part of the skin or body comes in direct contact with the panel, please wash thoroughly. If some physical symptoms result, please consult your doctor.



Follow local regulation or laws for safe disposal.

The backlight of the LCD panel contains mercury.

CAUTION

Handle with care when carrying the unit.

Disconnect the power cord and cables when moving the unit. Moving the unit with the cord attached is dangerous. It may result in injury.

When handling the unit, grip the bottom of the unit firmly with both hands ensuring the panel faces outward before lifting.

Dropping the unit may result in injury or equipment damage.

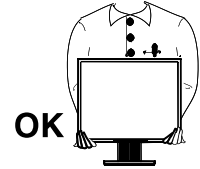

Do not block the ventilation slots on the cabinet.

- Do not place any objects on the ventilation slots.
- Do not install the unit in a closed space.
- Do not use the unit laid down or upside down.

Blocking the ventilation slots prevents proper airflow and may result in fire, electric shock, or equipment damage.



Do not touch the plug with wet hands.

Doing so may result in electrical shock.



Use an easily accessible power outlet.

This will ensure that you can disconnect the power quickly in case of a problem.

Periodically clean the area around the plug.

Dust, water, or oil on the plug may result in fire.

Unplug the unit before cleaning it.

Cleaning the unit while it is plugged into a power outlet may result in electric shock.

If you plan to leave the unit unused for an extended period, disconnect the power cord from the wall socket after turning off the power switch for the safety and the power conservation.

LCD Panel

In order to suppress the luminosity change by long-term use and to maintain the stable luminosity, use of a monitor in lower brightness is recommended.

The screen may have defective pixels. These pixels may appear as slightly light or dark areas on the screen. This is due to the characteristics of the panel itself, and not the product defect.

The backlight of the LCD panel has a fixed life span. When the screen becomes dark or begins to flicker, please contact your dealer.

Do not press on the panel or edge of the frame strongly, as this may result in damage to the screen. There will be prints left on the screen if the pressed image is dark or black. If pressure is repeatedly applied to the screen, it may deteriorate or damage your LCD panel. Leave the screen white to decrease the prints.

Do not scratch or press on the panel with any sharp objects, such as a pencil or pen as this may result in damage to the panel. Do not attempt to brush with tissues as this may scratch the LCD panel.

When the monitor is cold and brought into a room or the room temperature goes up quickly, dew condensation may occur inside and outside the monitor. In that case, do not turn the monitor on and wait until dew condensation disappears, otherwise it may cause damage to the monitor.

To use the monitor comfortably

An excessively dark or bright screen may affect your eyes. Adjust the brightness of the monitor according to the environmental conditions.

Staring at the monitor for a long time tires your eyes. Take a 10-minute rest every hour.

CONTENTS

PRECAUTIONS	1	2-7 Locking Buttons	18
LCD Panel.....	5	• To lock operation [Adjustment Lock].....	18
To use the monitor comfortably	5	2-8 Setting Adjustment menu Display	19
Chapter 1 Features and Overview	7	• To update menu settings	
1-1 Features	7	[Menu Size/Menu Position/Menu Off Timer/	
1-2 Buttons and Indicators	7	Translucent/Orientation]	19
1-3 Functions and Basic Operation	8	2-9 Viewing Information/Setting Language	20
Chapter 2 Settings and Adjustments	10	• To check settings, usage time, etc.	20
2-1 Utility Disk	10	• To set a language to be displayed	
• Disk contents and software overview	10	[Language]	20
• To use ScreenManager Pro for Medical	10	2-10 Setting BrightRegulator	20
2-2 Screen Adjustment	11	• [BrightRegulator] to set “Enable” or “Disable” for	
Digital Input.....	11	BrightRegulator.....	20
Analog Input	11	2-11 Resumption of Default Setting	20
2-3 Color Adjustment	14	• To reset color adjustment [Reset].....	20
Simple adjustment [CAL Switch mode].....	14	• To reset all settings [Reset]	20
• CAL Switch Mode.....	14	Chapter 3 Connecting Cables	21
• To select CAL Switch mode name.....	14	3-1 Connecting Two PCs to the Monitor	21
Advanced Adjustments [Adjustment menu].....	15	• To set auto-switching of input signals	
• To select an appropriate mode for images	15	[Input Signal]	22
• To set/adjust color	16	3-2 Connecting Peripheral USB Devices	22
2-4 Off Timer Settings	16	Chapter 4 Troubleshooting	23
• To set monitor power-off time [Off Timer]	16	Chapter 5 Reference	25
2-5 Screen Size Selection	17	5-1 Attaching an Arm (Option)	25
• To change screen size [Screen Size]	17	5-2 Cleaning	26
• To adjust brightness of non-display area		5-3 Specifications	27
[Border Intensity]	17	5-4 Glossary	29
2-6 Power Indicator/EIZO Logo Display Setting		5-5 Preset Timing	31
.....	18		
• To turn off the Power indicator while a screen is			
displayed [Power Indicator Setting]	18		
• To display EIZO logo			
[EIZO Logo Appearing Function]	18		

Chapter 1 Features and Overview

Thank you very much for choosing an EIZO color LCD monitor.

1-1 Features

- Dual-input compliant (DVI-I and D-sub mini 15-pin connectors)
- DVI digital input (TMDS) compliant
- Horizontal scan frequency: Analog: 24 - 80 kHz, Digital: 31 - 76 kHz
- Vertical scan frequency: Analog: 49 - 76 Hz (1600 × 1200: 49 - 61 Hz)
Digital: 59 - 61 Hz (VGA text: 69 - 71 Hz)
Resolution: 1600 dots × 1200 lines
- Compatible with frame synchronization mode (59 - 61 Hz)
- Smoothing (soft - sharp) function for adjustment of enlarged images
- BrightRegulator function incorporated
- DICOM mode (CAL Switch function)
- The utility software “ScreenManager Pro for Medical” (for Windows) to control the monitor from a PC with mouse/keyboard is included (refer to the EIZO LCD Utility Disk).
- Height adjustable stand
- Ultra slim bezel
- Portrait/Landscape display available

NOTE

- This monitor supports the Portrait/Landscape display. (The panel can be turned 90 degrees clockwise.)
- The stand of the unit can be replaced with an arm or another stand. (Refer to “5-1 Attaching an Arm” on page 25.)
- Select “Portrait” for <Orientation> on <Others> menu of the Adjustment menu to turn the menu 90 degrees.

1-2 Buttons and Indicators

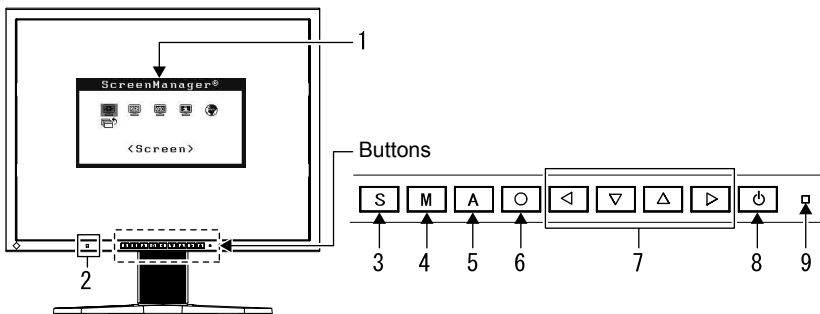

1. Adjustment menu (*ScreenManager[®])
2. Senser (BrightRegulator)
3. Input signal selection button
4. Mode button
5. Auto adjustment button
6. Enter button
7. Control buttons (Left, Down, Up, Right)
8. Power button
9. Power indicator

NOTE

- While a screen is displayed, the blue power indicator can be turned off (see “To turn off the Power Indicator while a screen is displayed,” on page 18).
- For the power indicator status with “Off Timer” set, refer to “To set monitor power-off time” on page 16.

Indicator status	Operation status
Blue	The screen is displayed
Yellow	Power saving
Off	Power off

* ScreenManager[®] is an EIZO's nickname of the Adjustment menu.

1-3 Functions and Basic Operation

To adjust the screen and color

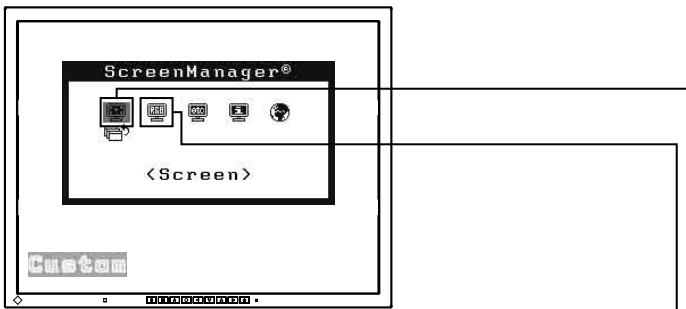

• The Adjustment menu and the CAL Switch mode name cannot be displayed at the same time.

M CAL Switch mode

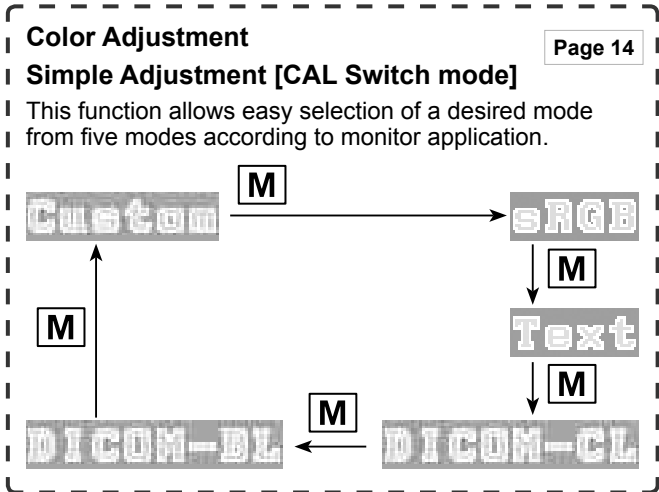

Color Adjustment

Page 14

Simple Adjustment [CAL Switch mode]

This function allows easy selection of a desired mode from five modes according to monitor application.

Brightness Adjustment

Page 15

Press **<** or **>** to adjust brightness.

A Analog input only

1 Screen Adjustment

Page 11

(Automatic Adjustment)

Press **A**.

Press **A** again while the message window is displayed.

O Adjustment menu (Refer to page 9 for operation)

2 Screen Adjustment

Page 11

(Advanced Adjustment)

[Adjustment menu]

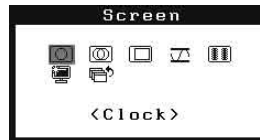

- [Clock] to remove vertical bars see page 12
- [Phase] to remove horizontal flickering and blur/distortion see page 12
- [Position] to correct screen position see page 12
- [Range Adjustment] to adjust color gradation automatically see page 13
- [Smoothing*] to adjust blurred texts/lines see page 13

* Function marked with * are also available for digital input.

Color Adjustment

Page 15

Advanced Adjustment [Adjustment menu]



- "Brightness," "Temperature," "Gamma," "Saturation," "Hue," and "Gain" can be set for each mode (Custom/sRGB/Text). Settable functions vary with the display mode.

Resuming the default settings

- Reset color adjustment [Reset] see page 20

To make useful settings/adjustments

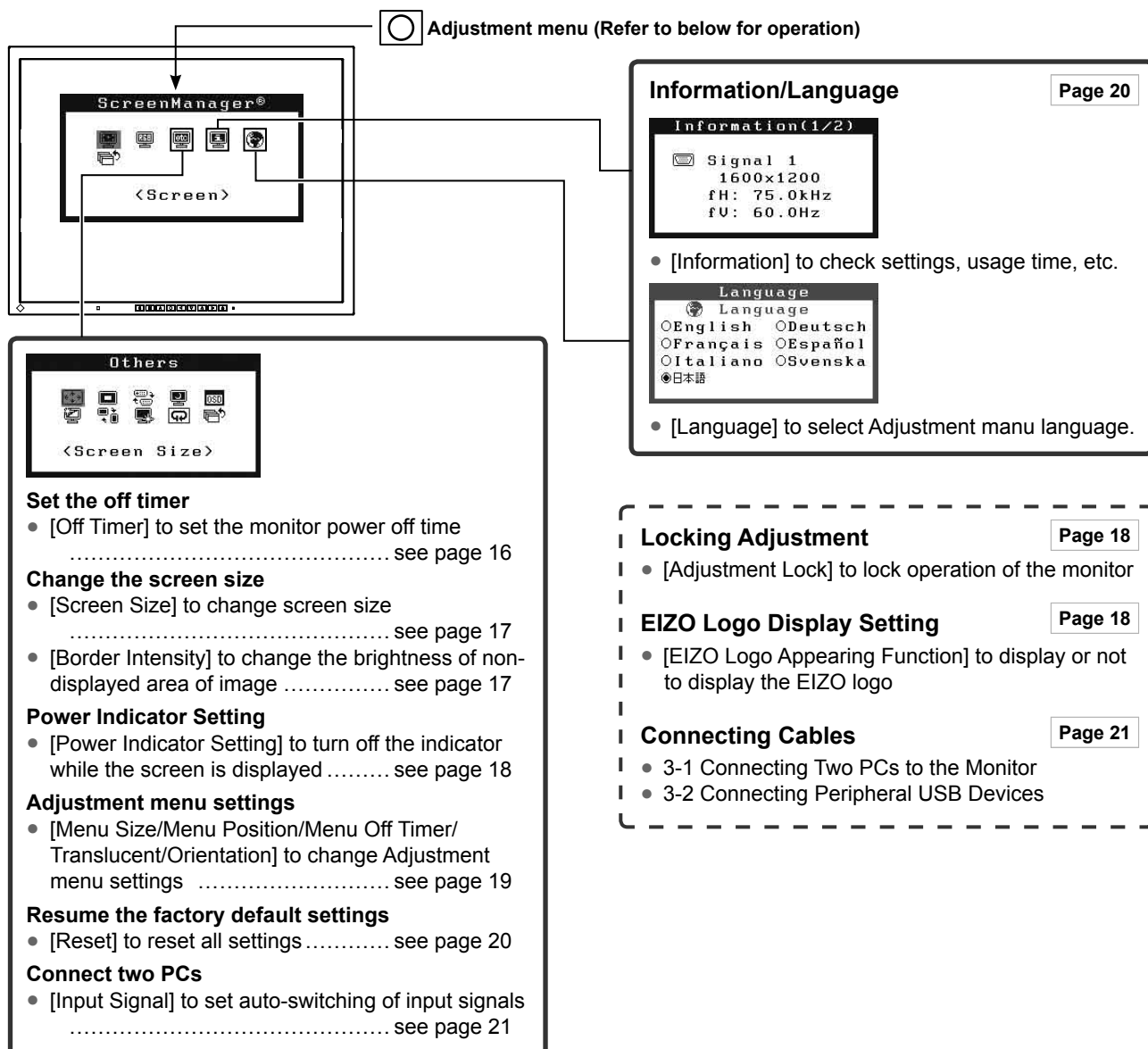

Basic operation of Adjustment menu

[Displaying Adjustment menu and selecting function]

- (1) Press . The main menu appears.
- (2) Select a function with ///, and press . The sub menu appears.
- (3) Select a function with ///, and press . The adjustment/setting menu appears.
- (4) Adjust the selected item with ///, and press . The setting is saved.

[Exiting Adjustment menu]

- (1) Choose <Return> from the sub menu and press .
- (2) Choose <Menu Off> from the main menu and press .

NOTE

- The Adjustment menu can also be exited by pressing twice quickly.
- <Menu off> or <Return> can also be selected by pressing the button twice in the Main menu or Sub menu.

Chapter 2 Settings and Adjustments

2-1 Utility Disk

An “EIZO LCD Utility Disk” (CD-ROM) is supplied with the monitor. The following table shows the disk contents and the overview of the application software programs.

• Disk contents and software overview

The disk includes a monitor information file, application software programs for adjustment, and User’s Manual. Refer to “readme.txt” or the “Readme” file on the disk for software startup procedures or file access procedures.

Item	Overview	For Windows	For Macintosh
A “readme.txt” or “Readme” file		○	○
Monitor information file (INF file)	Available for setting the best resolution and refresh rate for the monitor.	○	—
Color Profiles (ICC Profiles)	Color profiles	○	○
Screen Adjustment Program	Available for easy adjustments of the monitor screen following adjustment patterns and procedures on the screen.	○	○
ScreenManager Pro for Medical (for Windows) application software	A utility software program to control monitor adjustments from a PC using its mouse and keyboard. (A PC must be connected to the monitor with the supplied USB cable.) Refer to the description later.	○	—
User’s Manual of this monitor (PDF file)			

• To use ScreenManager Pro for Medical

For the installation and use of ScreenManager Pro for Medical, refer to its User’s Manual on the disk.

To adjust the monitor using ScreenManager Pro for Medical, connect a PC to the monitor with the supplied USB cable.

[Connection]

- (1) Connect the USB port (downstream) of a USB compatible PC (or other USB hub) and the monitor’s USB port (upstream) with the supplied USB cable.

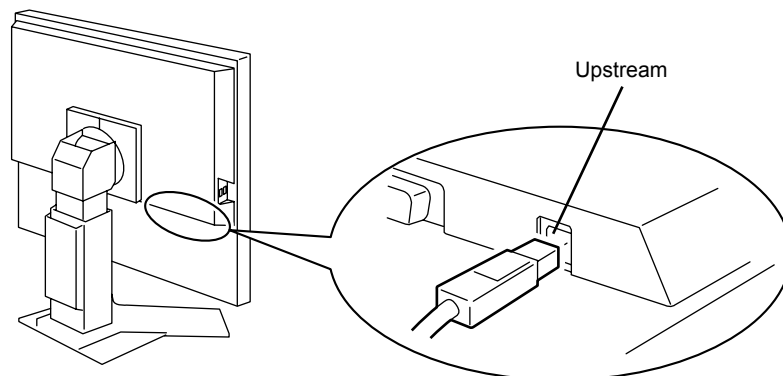

- (2) The USB function is set up automatically upon connection of the USB cable.

2-2 Screen Adjustment

Digital Input

When digital signals are input, images are displayed correctly based on the preset data of the monitor.

Analog Input

The monitor screen adjustment is used to suppress flickering of the screen or adjust screen position and screen size correctly according to the PC to be used. To use the monitor comfortably, adjust the screen when the monitor is set up for the first time or when the settings of the PC in use are updated.

[Adjustment Procedure]

• Automatic Adjustment

1 Press **A**.

A message “Your setting will be lost if you press again now” appears for five seconds.

2 Press **A** again while the message is displayed.

The Auto Adjustment function begins (showing a running status message) to adjust clock, phase, display position, and resolution automatically.

If satisfactory adjustment cannot be obtained with the **A button, perform the adjustment following the procedure below. When the screen is displayed correctly, go to step 5 “Range Adjustment”.**

• Advanced Adjustment

3 Run the Screen Adjustment Program.

Load the EIZO LCD Utility Disk on the PC, and start the Screen Adjustment Program compatible with the PC in use.

After the program starts up, perform the adjustment in step 4 following the instructions of the program.

Attention

- Wait 20 minutes or more from monitor power on before starting adjustments.
(This period of time is required to stabilize the operation of internal electronic components.)

NOTE

- Auto adjustment is available using **A**. If satisfactory adjustment cannot be obtained with this button, perform advanced adjustments using the Adjustment menu.
- Use “Screen Adjustment Program” on the supplied EIZO LCD Utility Disk.

Attention

- This function works correctly when an image is fully displayed over the Windows or Macintosh display area. It does not work properly when an image is displayed only on a part of the screen (DOS prompt window, for example) or when a black background (wallpaper, etc.) is in use.
- This function does not work correctly with some graphics boards.



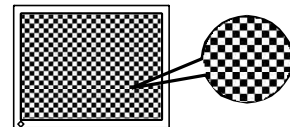

NOTE

- For how to start the Screen Adjustment Program, refer to “readme.txt” or the “Readme” file. When you are using a Windows PC, you can run the program directly from the start menu of the disk.
- If no adjustment program is available for your PC, display a checkerboard pattern on the screen (see below) and go to the following steps.





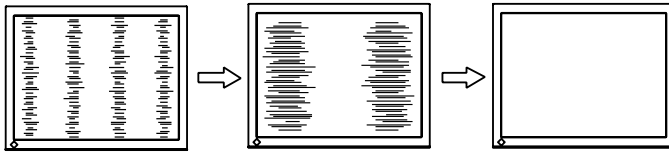

4 Perform advanced adjustments for the following using the <Screen> menu of the Adjustment menu.

- **To eliminate vertical bars [Clock]**

- (1) Choose <Clock> from the <Screen> menu, and press .
The <Clock> menu appears.
- (2) Adjust the clock with  or , and press .
The adjustment is completed.





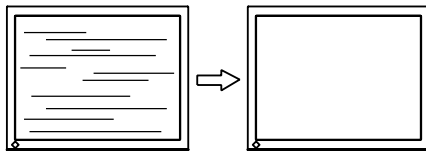

- **To remove flickering or blurring [Phase]**

- (1) Choose <Phase> from the <Screen> menu, and press .
The <Phase> menu appears.
- (2) Adjust the phase with  or , and press .
The adjustment is completed.



- **To correct screen position [Position]**

Since the number of pixels and the pixel positions are fixed on the LCD monitor, only one position is provided to display images correctly. The position adjustment is made to shift an image to the correct position.

- (1) Choose <Position> from the <Screen> menu, and press .
The <Position> menu appears.
- (2) Adjust the position with , , , or  to display the image properly in the display area of the monitor.

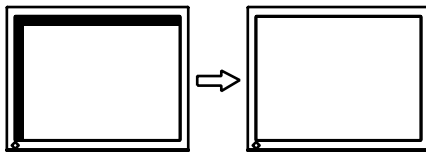

NOTE

- Press the control button slowly so as not to miss the adjustment point.
- When blurring, flickering or bars appear on the screen after adjustment, proceed to [Phase] to remove flickering or blurring.

Attention

- Flickering or blurring may not be eliminated depending on your PC or graphics board.

NOTE

- When vertical bars appear on the screen after adjustment, go back to “To eliminate vertical bars [Clock].” (Clock → Phase → Position)

5 Adjust the signal output range

- **To adjust color gradation automatically [Range Adjustment]**

Every color gradation (0 to 255) can be displayed by adjusting the signal output level.

- (1) Choose <Range Adjustment> from the <Screen> menu, and press .

A message “Your setting will be lost if you press AUTO button” appears.

- (2) Press while the message is displayed.

The output range is adjusted automatically to display images with the maximum color gradation.

All the adjustments using the “Screen Adjustment Program” are completed.

6 Change the smoothing setting.

- **To modify blurred characters/lines [Smoothing]**

When a low-resolution image is displayed, the characters or lines of the displayed image may be blurred.

- (1) Choose <Screen> from the Adjustment menu, and press .
- (2) Choose <Smoothing> from the <Screen> menu, and press .

The <smoothing> menu appears.

- (3) Select a suitable level from 1 to 5 (where 1 = soft and 5 = sharp) with or , and press .

The <smoothing> menu appears.

Attention

- [Smoothing] is disabled when the screen is displayed with a resolution of 1600 × 1200 or 800 × 600.
- Blurring is not eliminated completely because the screen is enlarged display.

2-3 Color Adjustment

Simple adjustment [CAL Switch mode]

This function allows you to select the best display mode for monitor brightness, etc.

• CAL Switch Mode

An appropriate display mode is selectable out of five modes.

Mode	Purpose
Custom	Available for making desired setting.
sRGB	Suitable for color matching with sRGB compatible peripherals.
Text	Suitable for displaying texts for word processing or spreadsheets.
DICOM-CL	Available for setting tailored to X-ray film color (clear base).
DICOM-BL	Available for setting tailored to X-ray film color (blue base).

CAL Switch mode name

Example: Custom



— Displays current mode.

• To select CAL Switch mode name

- (1) Press **[M]**.
The CAL Switch mode name appears at the lower left of the screen.
- (2) One of five modes is displayed in turn each time **[M]** is pressed.
- (3) Press **[O]** to quit the operation.

NOTE

- The Adjustment menu and the CAL Switch mode name cannot be displayed at the same time.
- This menu ends automatically when 2 seconds pass after the **[M]** button is pressed.

Advanced Adjustments [Adjustment menu]

Independent setting and saving of color adjustment are available for each CAL Switch mode.

• To select an appropriate mode for images

✓: Adjustment/setting available -: Factory setting

Icon	Function	CAL Switch mode				
		Custom	sRGB	Text	DICOM-CL	DICOM-BL
	Brightness	✓	✓	✓	-	-
	Temperature	✓	-	✓	-	-
	Gamma	✓	-	✓	-	-
	Saturation	✓	-	✓	-	-
	Hue	✓	-	✓	-	-
	Gain	✓	-	-	-	-
	Reset	✓	-	✓	-	-



Menu	Description	Adjustment range
Brightness 	To adjust the full screen brightness as desired	0 to 100%
	NOTE • You can also adjust the brightness by pressing or . Press after adjustment.	
Temperature 	To select a color temperature	4000K to 10000K in units of 500K (including 9300K).
	NOTE • The values shown in the Kelvin (K) are available only as reference. • The setting automatically turns "OFF" if a value under 4,000K or over 10,000K is set.	
Gamma 	To set a gamma value	1.8/2.0/2.2
	NOTE • Digital signal input is recommended for gamma value setting.	
Saturation 	To adjust color saturation	-128 to 127 Setting the minimum (-128) turns the image to a monochrome screen.
	Attention • This function does not enable to display every color gradation.	
Hue 	To change the flesh color, etc.	-32 to 32
	Attention • This function does not enable to display every color gradation.	

Attention







- Perform [Range Adjustment] before starting color adjustment for analog input signals.
Refer to "To adjust color gradation automatically" on page 12.
- The CAL Switch mode cannot be changed during color adjustment. Set the CAL Switch mode in advance with **[M]**.
- Wait 20 minutes or more from monitor power on before starting the color adjustment.
(It takes about 20 minutes for stable operation of internal electronic components.)
- Choose [Reset] from the Color menu to revert to the default setting (factory setting) of the color tone of the CAL Switch mode selected.
- The same image may be seen in different colors on multiple monitors due to their monitor-specific characteristics. Make fine color adjustment visually when matching colors on multiple monitors.

NOTE

- The Adjustment menu and the CAL Switch mode name cannot be displayed at the same time.
- Adjustable functions vary depending on the type of CAL Switch mode.

Menu	Description	Adjustment range
Gain 	To adjust red, green, and blue to a desired color tone respectively	0 to 100% Adjust the respective brightness of red/green/blue to make a desired color tone. Display an image with white or gray background for adjustment.
NOTE <ul style="list-style-type: none"> • Values shown in percentage are available only as reference. • The <Temperature> setting invalidates this setting. The <Gain> setting returns to the default setting. 		
Reset 	To reset the color settings of the selected CAL Switch mode to the default settings.	Select [Reset].

• To set/adjust color

- (1) Choose <Color> from the Adjustment menu, and press .
 - (2) Select a desired function from the <Color> menu, and press .
The selected function menu appears.
 - (3) Adjust the selected item with , , , , and press .
- The adjustment is completed.

2-4 Off Timer Settings

• To set monitor power-off time [Off Timer]

This function allows the monitor to automatically turn off after a specified time has passed. This function serves to reduce afterimages caused when the monitor screen is left on for a long time period without use. Use this function when an image is displayed throughout the day.

Attention







- The Off Timer functions even in the power saving mode, but the advance notice is disabled. The monitor power is turned off without advance notice.

[Off Timer System]

Timer	Monitor	Power Indicator
ON time (1H - 23H)	Operating	Blue
Last 15 min. in "ON time"	Advance Notice*1	Flashing blue
"ON time" expired	Power Off	Off

*1 When  is pressed during the advance notice period, the monitor continues to operate for additional 90 minutes. Extension of operation time can be set without limitation.

[Procedure]

- (1) Choose <Others> from the Adjustment menu, and press .
 - (2) Choose <Off Timer> from the <Others> menu, and press .
The <Off Timer> menu appears.
 - (3) Select "Enable" with  or .
 - (4) Set a monitor ON time (1 to 23 hours) with  or , and press .
- The Off Timer setting is completed.

[Resumption Procedure]

Press .

2-5 Screen Size Selection

• To change screen size [Screen Size]

This function allows you to change the screen size when a low-resolution image is displayed.

Menu	Function
Full (default setting)	Displays an image in full screen. Images are distorted in some cases because the vertical rate is not equal to the horizontal rate.
Enlarged	Displays an image in full screen. In some cases, a blank horizontal or vertical border appears to equalize the vertical rate and the horizontal rate.
Normal	Displays images with the specified resolution.

Example: Image size 1280 × 1024

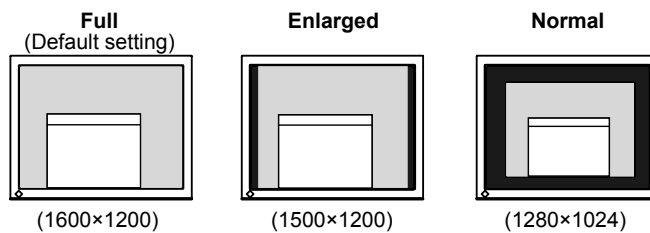

[Procedure]

- (1) Choose <Others> from the Adjustment menu, and press .
- (2) Choose <Screen Size> from the <Others> menu, and press .
- The screen size setting window appears.
- (3) Select “Full,” “Enlarged,” or “Normal” with or , and press .
- The screen size setting is completed.

• To adjust brightness of non-display area [Border Intensity]

A border (black area with no image) around the image appears in the “Normal” or “Enlarged” mode.

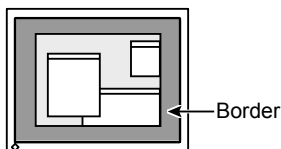

- (1) Choose <Others> from the Adjustment menu, and press .
- (2) Choose <Border Intensity> from the <Others> menu, and press .
- The <Border Intensity> menu appears.
- (3) Adjust border intensity with or , and press .
- The border intensity adjustment is completed.

2-6 Power Indicator/EIZO Logo Display Setting

• To turn off the Power indicator while a screen is displayed [Power Indicator Setting]

This function enables to turn off the Power indicator (blue) while a screen is displayed.

- (1) Choose <Others> from the Adjustment menu, and press .
 - (2) Choose <Power Indicator> from the <Others> menu, and press .
The <Power Indicator> menu appears.
 - (3) Select "Disable" with or , and press .
- The Power Indicator setting is completed.

• To display EIZO logo [EIZO Logo Appearing Function]

When this unit is turned on, the EIZO logo appears at the center of the screen. Selection to display or not to display the logo is available with this function.

[Procedure]

- (1) Press to power off the unit.
 - (2) Press again while pressing .
- The EIZO logo does not appear on the screen.

[Resetting]

- (1) Press to power off the unit.
 - (2) Press again while pressing .
- The logo appears again.

2-7 Locking Buttons

• To lock operation [Adjustment Lock]

This function locks the buttons to retain the status adjusted or set once.

Buttons that can be locked	<ul style="list-style-type: none"> • <input type="button" value="O"/> (Enter button) Adjustments/settings using Adjustment menu • <input type="button" value="A"/> (Auto adjustment button) • <input type="button" value="M"/> (Mode button) CAL Switch mode name selection • <input type="button" value="◀"/> / <input type="button" value="▶"/> (Control buttons) Brightness adjustment
Buttons that cannot be locked	<ul style="list-style-type: none"> • <input type="button" value="⏻"/> (Power button) • <input type="button" value="S"/> (Input signal selection button)

[Procedure]

- (1) Press to turn off the unit.
 - (2) Press again while pressing .
- The screen is displayed with the adjustment lock.

[Unlocking]

- (1) Press to turn off the unit.
 - (2) Press again while pressing .
- The screen is displayed with the adjustment lock released.

NOTE

- The logo appears with the default setting.

2-8 Setting Adjustment menu Display

- To update menu settings [Menu Size/Menu Position/Menu Off Timer/Translucent/Orientation]

Menu Size

Change the Adjustment menu size using the following procedure.

- (1) Choose <Others> from the Adjustment menu, and press .
- (2) Choose <Menu Settings> from the <Others> menu, and press .
- (3) Choose <Menu Size> from the <Menu Settings> menu, and press
The <Menu Size> menu appears.
- (4) Select “Enlarged” using or , and press .

The menu size setting is completed.

Menu Position

Adjust the menu position using the following procedure.

- (1) Choose <Others> from the Adjustment menu, and press .
- (2) Choose <Menu Settings> from the <Others> menu, and press .
- (3) Choose <Menu Position> from the <Menu Settings> menu, and press
The <Menu Position> menu appears.
- (4) Select a menu position with , , , or , and press .

The menu position setting is completed.

Menu Off Timer

Set the menu display time using the following procedure.

- (1) Choose <Others> from the Adjustment menu, and press .
- (2) Choose <Menu Settings> from the <Others> menu, and press .
- (3) Choose <Menu Off Timer> from the <Menu Settings> menu, and press
The <Menu Off Time> menu appears.
- (4) Choose “Enable” with or .
- (5) Choose an Off Time (15/30/45/60 seconds) with or , and press .

The menu off timer setting is completed.

Translucent

Set the transparency for menu display using the following procedure.

- (1) Choose <Others> from the Adjustment menu, and press .
- (2) Choose <Menu Settings> from the <Others> menu, and press .
- (3) Choose <Translucent> from the <Menu Settings> menu, and press
The <Translucent> menu appears.
- (4) Adjust the transparency for menu display with or , and press .

The transparency setting is completed.

Orientation

The orientation of the Adjustment menu can be turned 90 degrees.

- (1) Choose <Others> from the Adjustment menu, and press .
- (2) Choose <Orientation> from the Others menu, and press
The <Orientation> menu appears.
- (3) Select “Landscape” or “Portrait” with or , and press .

The orientation setting is completed.

NOTE

- The display time of the CAL Switch mode name remains unchanged.

2-9 Viewing Information/Setting Language

• To check settings, usage time, etc.

[Information]

This function allows you to check settings, model name, serial number, and usage time of the monitor.

- (1) Choose <Information> from the Adjustment menu, and press .

The <Information> menu appears.

- (2) Then, press to check settings, etc.

• To set a language to be displayed [Language]

Select the Adjustment menu language.

Selectable languages

English/German/French/Spanish/Italian/Swedish/Japanese

- (1) Choose <Language> menu from the Adjustment menu, and press .

The <Language> menu appears.

- (2) Select a language with <input type="button" value="▼"/><input type="button" value="◀"/><input type="button" value="▶"/>, and press .

The language setting is completed.

NOTE

- The usage time is not always “0” when you purchase the monitor due to factory inspection.

2-10 Setting BrightRegulator

• [BrightRegulator] to set “Enable” or “Disable” for BrightRegulator.

- (1) Choose <Others> from the Adjustment menu, and press .

- (2) Choose < BrightRegulator> from the <Others> menu, and press .

The BrightRegulator setting window appears.

- (3) Select “Enable” or “Disable” with or , and press .

The BrightRegulator setting is completed.

NOTE

- The BrightRegulator icon is not selectable when the CAL switch mode is DICOM-BL or DICOM-CL.

2-11 Resumption of Default Setting

• To reset color adjustment [Reset]

Resume the default settings (factory settings) for color adjustment.

- (1) Choose <Color> from the Adjustment menu, and press .

- (2) Choose <Reset> from the <Color> menu, and press .

The <Reset> menu appears.

- (3) Select <Reset> with or , and press .

The reset operation is completed.

• To reset all settings [Reset]

Reset all adjustments/settings to the factory default settings.

- (1) Choose <Others> from the Adjustment menu, and press .

- (2) Choose <Reset> from the <Others> menu, and press .

The <Reset> menu appears.

- (3) Select <Reset> with or , and press .

The reset operation is completed.

NOTE

- For default settings, refer to “Main default settings (factory settings)” on page 28.

Chapter 3 Connecting Cables

3-1 Connecting Two PCs to the Monitor

Two PCs can be connected to the monitor through the DVI-I and the D-Sub mini 15 pin connector on the back of the monitor.

Connection examples

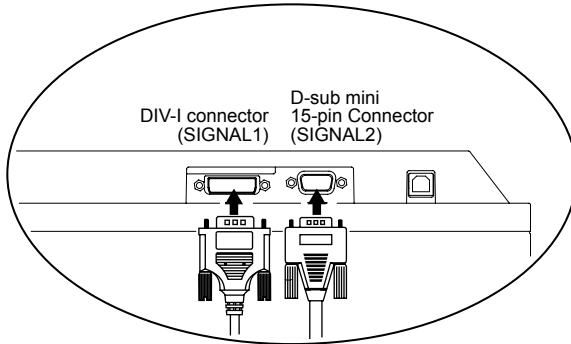

		PC 1		PC 2	
Example 1	Digital	DVI	Signal cable (supplied with FD-C39)	Signal cable (supplied MD-C87)	Analog
Example 2	Analog	D-sub mini 15-pin	Signal cable (FD-C16 option)	Signal cable (supplied MD-C87)	Analog

Selecting input signal

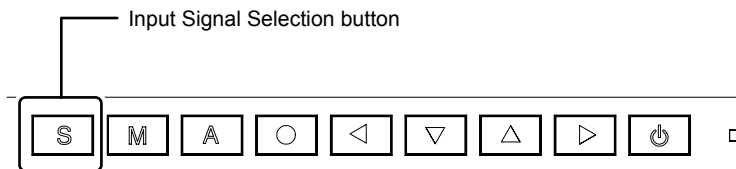

Switch the input signal with **[S]**. Input signal switches each time **[S]** is pressed. When the signal is switched, the active signal type (Analog or Digital) appears at the top right corner of the screen for two seconds.

Attention

- When using an optional signal cable (FD-C16), be sure to connect the D-sub mini 15-pin connector to the PC, and the DVI-I connector to the monitor. Wrong connection may result in no picture display.

- **To set auto-switching of input signals [Input Signal]**

The monitor recognizes the connector through which PC signals are input. When either PC is turned off or enters the power-saving mode, the monitor automatically displays signals of another PC.

Priority setting	Function
Auto	When either PC is turned off or enters the power-saving mode, the monitor automatically displays signals of another PC.
Manual	The monitor does not detect the PC's signals automatically. Select an active input signal with [S] .

[Input signal setting]

- (1) Choose <Others> from the Adjustment menu, and press **[O]**.
- (2) Choose <Input Signal> from the <Others> menu, and press **[O]**.
The <Input Signal> menu appears.
- (3) Select "Auto" or "Manual" with **[Δ]** or **[▽]**, and press **[O]**.
The Input Priority setting is completed.

3-2 Connecting Peripheral USB Devices

This monitor has a hub compatible with USB. Connected to a PC compatible with USB or another USB hub, this monitor functions as a USB hub allowing connection to peripheral USB devices.

- **Required System Environment**
 - (1) A PC equipped with a USB port or another USB hub connected to a USB compatible PC
 - (2) Windows 98/Me/2000/XP or Mac OS 8.5.1 or later
 - (3) Supplied EIZO USB cable (MD-C93)
- **Connection Procedure (Setup of USB Function)**
 - (1) Connect the monitor first to a PC using the signal cable, and run the PC.
 - (2) Connect the supplied USB cable between the downstream USB port of a USB compatible PC (or another USB hub) and the monitor's upstream USB port.
 - (3) When the USB function setup is completed, the monitor functions as a USB hub allowing connection to various peripheral USB devices through its downstream USB ports.

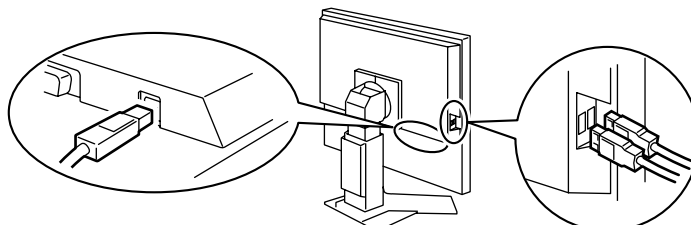

The USB function is set up automatically upon connection of the USB cable.





Attention

- This monitor may not work depending on PC, OS or peripheral devices to be used.
For USB compatibility of peripheral devices, contact their manufactures.
- If the Main Power switch of the monitor is not turned on, the connected downstream peripheral devices do not work.
- Even if the monitor enters the sleep mode, all the devices connected to the USB ports (upstream and downstream) work. (Therefore the monitor power consumption varies with connected devices even in the sleep mode.)

Chapter 4 Troubleshooting

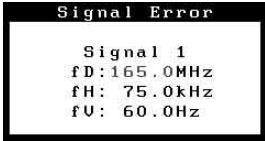
If a problem still remains after applying the suggested remedies, contact your local dealer.

- No-picture problems → See No.1 - No.2.
- Imaging problems → See No.3 - No.11.
- Other problems → See No.12 - No.18.

Problems	Possible cause and remedy
<p>1. No picture</p> <ul style="list-style-type: none"> • Power indicator does not light. 	<ul style="list-style-type: none"> • Check whether the power cord is connected correctly. If the problem persists, turn off the monitor, and then turn it on again a few minutes later.
<ul style="list-style-type: none"> • Power indicator is lighting blue. • Power indicator is lighting yellow. 	<ul style="list-style-type: none"> • Check brightness setting. • Turn on the PC. • Switch the input signal with [S]. • Operate the mouse or keyboard.
<p>2. The message below appears.</p> <ul style="list-style-type: none"> • This message appears when no signal is input. (This is displayed for about 40 seconds.) 	<p>This message appears when the signal is not input correctly even when the monitor functions properly.</p> <ul style="list-style-type: none"> • The message shown left may appear, because some PCs do not output the signal soon after power-on. • Check whether the PC is turned on. • Check whether the signal cable is connected properly. • Switch the input signal with [S].
<ul style="list-style-type: none"> • The message below shows that the input signal is out of the specified frequency range. (Such signal frequency is displayed in red.) <p>Example:</p> 	<ul style="list-style-type: none"> • Select an appropriate display mode using the graphics board's utility software. Refer to the manual of the graphics board for details.
<p>3. Display position is incorrect.</p> 	<ul style="list-style-type: none"> • Adjust image position so that it is displayed properly within the display area using the <Position> adjustment. • If the problem persists, use the graphics board's utility software if available to change the display position.
<p>4. Vertical bars appear on the screen or a part of the image is flickering.</p> 	<ul style="list-style-type: none"> • Adjust using <Clock> from <Screen> menu at the Adjustment menu.
<p>5. Whole screen is flickering or blurring.</p> 	<ul style="list-style-type: none"> • Adjust using <Phase>.
<p>6. Characters are blurred.</p>	<ul style="list-style-type: none"> • Adjust using <Smoothing>.
<p>7. Upper part of the screen is distorted as shown below.</p> 	<ul style="list-style-type: none"> • This is caused when both composite sync (X-OR) signal and separate vertical sync signal are input simultaneously. Select either composite signal or separate signal.

Problems	Possible cause and remedy
8. The screen is too bright or too dark.	<ul style="list-style-type: none"> Adjust <Brightness>. (The LCD monitor backlight has a fixed life span. When the screen becomes dark or begins to flicker, contact your local dealer.)
9. Afterimages appear.	<ul style="list-style-type: none"> Use a screen saver or off timer function for a long-time image display. Afterimages are particular to LCD monitors. Avoid displaying the same image for a long time.
10. Green/red/blue/white dots or defective dots remain on the screen.	<ul style="list-style-type: none"> This is due to LCD panel characteristics and is not a failure.
11. Interference patterns or fingerprints remain on the screen.	<ul style="list-style-type: none"> Leave the monitor with a white screen. The symptom may disappear.
12. Noise appears on the screen.	<ul style="list-style-type: none"> Select 1 to 4 in <Signal Filter> from the <Screen> menu to change the mode.
13. The [Smoothing] icon on the Adjustment menu [Screen] cannot be selected.	<ul style="list-style-type: none"> <Smoothing> is disabled with a resolution of 1600 × 1200 or 800 × 600 <Smoothing> cannot be selected when the resolution is doubled with <Screen Size> menu. (Example: 640 × 480 is enlarged to 1280 × 960)
14. The Main menu of Adjustment menu does not start.	<ul style="list-style-type: none"> Check for Adjustment Lock function.
15. The [A] button does not function.	<ul style="list-style-type: none"> The [A] button does not function when digital signal is input. Check whether the buttons are lockd. This function works correctly when an image is fully displayed over the Windows or Macintosh display area. It does not work properly when an image is displayed only on a part of the screen (DOS prompt window, for example) or when a black background (wallpaper, etc.) is in use. This function does not work correctly with some graphics boards.
16. Frequency does not change after the utility disk is installed on Windows 98/Me/2000/XP.	<ul style="list-style-type: none"> Change the input signal frequency using the graphics board's utility software.
17. USB function cannot be set up.	<ul style="list-style-type: none"> Check whether the USB cable is connected correctly. Check whether the PC and OS are USB compliant. (For USB compliance of the respective devices, consult their manufacturers.) Check the PC's BIOS setting for USB when using Windows 98/Me/2000/XP. Refer to the manual of the PC for details.)
18. The PC does not work/USB devices connected to the monitor do not work.	<p>Check whether the USB cable is connected correctly.</p> <ul style="list-style-type: none"> Change the cable connection to another USB port. If the PC works normally with this port change, contact your local dealer. (Refer to the manual of the PC for details.) Try the following: <ul style="list-style-type: none"> Reboot the PC. <p>Connect the PC directly to the peripheral devices. When the devices work normally without being connected to the monitor (USB hub), contact your local dealer.</p>

Chapter 5 Reference

5-1 Attaching an Arm (Option)

The stand can be removed and replaced with an arm (or another stand) to be attached to the monitor. Use an arm or stand of EIZO option.

[Attaching]

- 1** Hold the upper and lower centers of the stand joint cover, and slide sideways to remove it.

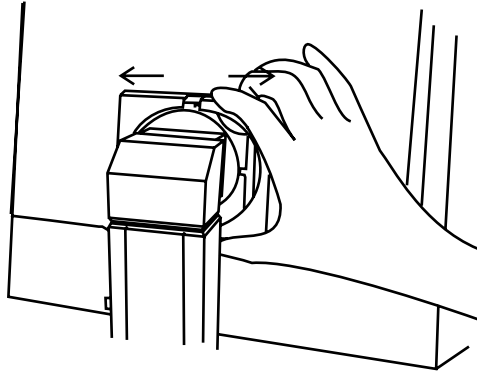

- 2** Lay the LCD monitor on a soft cloth spread over on a stable surface with the panel surface facing down.

- 3** Remove the stand. (Prepare a screwdriver.)

Unscrew the two screws (M4 × 10mm) securing the unit and the stand with the screwdriver.

- 4** Attach the monitor to the arm or stand.

Secure the stand to the monitor with four screws (M4 × 12mm) using a screwdriver.

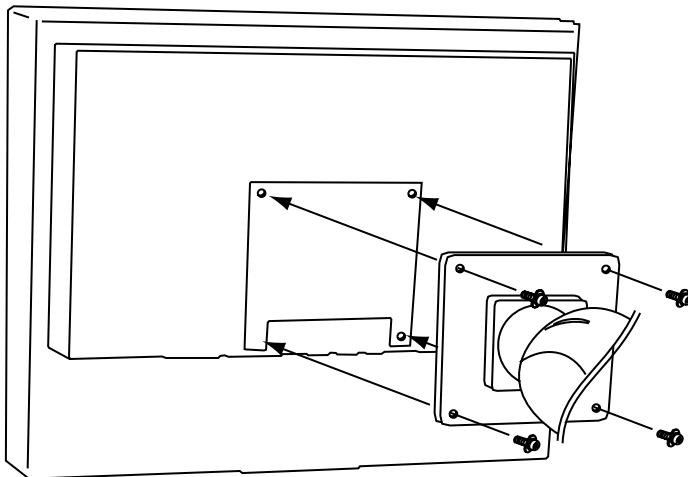

Fixing screws: M4 × 12mm 4 pcs

Attention

- When using another manufacturer's arm or stand, confirm the following in advance.
- Clearance between the holes of the arm fixing screws: 100 mm × 100 mm (VESA compliant)
- Strong enough to support weight of the monitor unit (except the stand) and attachments such as cables
- Connect the cables after attaching an arm.

5-2 Cleaning

Clean the monitor periodically to keep the monitor clean and extend its life.

Cabinet

Clean the cabinet with a soft cloth dampened with little mild detergent.

LCD Panel

- Clean the LCD panel with a soft cloth such as cotton cloth or lens cleaning paper.
- Remove persistent stains gently with a cloth dampened with little water, and then clean the LCD panel again with a dry cloth for better finishing.

Attention

- Never use any solvents or chemicals, such as thinner, benzene, wax, alcohol, and abrasive cleaner, which may damage the cabinet or LCD panel.

NOTE

- Optional ScreenCleaner is recommended for cleaning the panel surface.

5-3 Specifications

LCD Panel	21.3-inch (540 mm) TFT color LCD with anti-glare hard coating Viewing angle: Vertical 178°, Horizontal 178° (CR: 10 or more)	
Dot Pitch	0.270 mm	
Horizontal Scan Frequency	Analog: 24 - 80 kHz (Automatic) Digital: 31 - 76 kHz	
Vertical Scan Frequency	Analog: 49 - 76 Hz (Automatic) (1600 × 1200: 49 - 61 Hz) Digital: 59 - 61 Hz (VGA TEXT: 69 - 71 Hz)	
Resolution	1600 dots × 1200 lines	
Max. Dot Clock	Analog: 162 MHz Digital: 162 MHz	
Max. Display Colors	16.77 million colors	
Display Area (H × V)	432 mm × 324 mm	
Power Supply	100 - 120 VAC ±10% 50/60 Hz, 0.7 A 200 - 240 VAC ±10% 50 Hz, 0.4 A	
Power Consumption	Max.:70 W (USB device connected) Power saving mode: 2 W or less (for single signal input with no USB device connected) Power switch Off: 1 W or less	
Input Signal Connectors	DVI-I connector, D-sub mini 15-pin connector	
Analog Input Signal (Sync)	a)Separate, TTL, positive/negative	
	b)Composite, TTL, positive/negative	
Analog Input Signal (Video)	Analog, positive (0.7 Vp-p/75 Ω)	
Digital Signal Transmission System	TMDS (Single Link)	
Video Signal Memory	Analog signal: 45 (preset: 22)	
	Digital Signal: 10 (preset: 0)	
Plug & Play	VESA DDC 2B	
Dimensions (Main unit)	465 mm (W) × 453 - 535 mm (H) × 208.5 mm (D) (18.3" (W) × 17.8"-21.1" (H) × 8.2" (D))	
Dimensions (without stand)	465 mm (W) × 361 mm (H) × 64 mm (D) (18.3" (W) × 14.2" (H) × 2.52" (D))	
Weight (Main unit)	9.7 kg (21.4 lbs)	
Weight (without stand)	6.7 kg (14.8 lbs)	
Environmental Conditions	Operating temperature: 0 °C - 35 °C Storage temperature: -20 °C - 60 °C Relative humidity: 30% - 80% (no condensation)	
USB	Standard	Rev. 2.0 compliant
	Port	Upstream port × 1, Downstream port × 2
	Transmission rate	480 Mbps (High speed) 12 Mbps (Full speed) 1.5 Mbps (Low speed)
	Supply current	Downstream: Max. 500 mA/1 port

Main default settings (factory settings)

BrightRegulator	Enable	
Smoothing	3	
CAL Switch Mode	Custom	
Screen Size	Full	
Input Signal	Auto	
Off Timer	Disabled	
Setting	Size	Normal
	Off Timer	45 seconds
Language	English	

Outside Dimensions

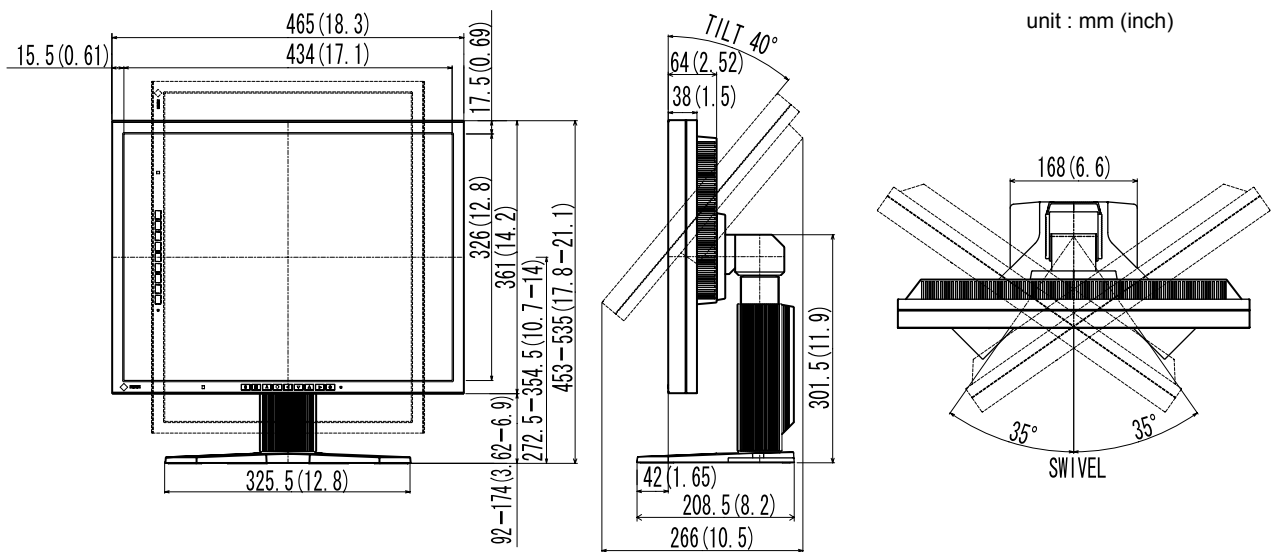

Connector Pin Assignment

- DVI-I connector

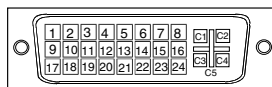

Pin No.	Signal	Pin No.	Signal	Pin No.	Signal
1	TMDS Data 2-	11	TMDS Data1/3 Shield	21	NC*
2	TMDS Data 2+	12	NC*	22	TMDS Clock shield
3	TMDS Data2/4 Shield	13	NC*	23	TMDS Clock+
4	NC*	14	+5V Power	24	TMDS Clock-
5	NC*	15	Ground (return for +5V, Hsync and Vsync)	C1	Analog Red
6	DDC Clock (SCL)	16	Hot Plug Detect	C2	Analog Green
7	DDC Data (SDA)	17	TMDS Data0-	C3	Analog Blue
8	Analog Vertical Sync	18	TMDS Data0+	C4	Analog Horizontal Sync
9	TMDS Data1-	19	TMDS Data0/5 Shield	C5	Analog Ground (analog R,G,&B return)
10	TMDS Data1+	20	NC*		

(NC*: No Connection)

- D-sub mini 15-pin connector

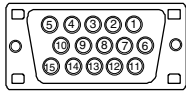

Pin No.	Signal	Pin No.	Signal	Pin No.	Signal
1	Red	6	Red ground	11	(Short-circuited to pin 10)
2	Green	7	Green ground	12	Data (SDA)
3	Blue	8	Blue ground	13	H. Sync
4	Ground	9	NC	14	V. Sync
5	NC	10	Ground	15	Clock (SCL)

- USB port

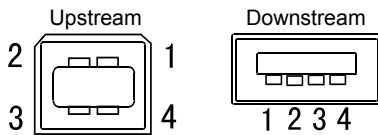

Contact No.	Signal	Remarks
1	VCC	Cable power
2	- Data	Serial data
3	+ Data	Serial data
4	Ground	Cable ground

Option List

Cleaning Kit	EIZO ScreenCleaner
--------------	--------------------

5-4 Glossary

Clock

The analog input monitor needs to reproduce a clock of the same frequency as the dot clock of the graphics system in use, when the analog input signal is converted to a digital signal for image display.

This is called clock adjustment. If the clock pulse is not set correctly, some vertical bars appear on the screen.

DICOM (Digital Imaging and Communication in Medicine)

DICOM is a standard for digital imaging and communication for medical use developed by American College of Radiology and National Electric Manufacturers Association.

DVI (Digital Visual Interface)

DVI is a digital interface standard. DVI allows direct transmission of the PC's digital data without loss.

This adopts the TMDS transmission system and DVI connectors. There are two types of DVI connectors. One is a DVI-D connector for digital signal input only. The other is a DVI-I connector for both digital and analog signal inputs.

Gain

This is used to adjust each color parameter for red, green and blue. An LCD monitor displays the color by the light passing through the panel color filter. Red, green and blue are the three primary colors. All the colors on the screen are displayed by combining these three colors. The color tone can be changed by adjusting the light intensity (volume) passing through each color's filter.

Gamma

Generally, the monitor brightness varies nonlinearly with the input signal level, which is called “Gamma Characteristic”. A small gamma value produces a low-contrast image, while a large gamma value produces a high-contrast image.

Phase

Phase means the sampling timing to convert the analog input signal to a digital signal. Phase adjustment is made to adjust the timing. It is recommended that phase adjustment be made after the clock is adjusted correctly.

Range Adjustment

Range adjustment controls the signal output levels to display every color gradation. It is recommended that range adjustment be made before color adjustment.

Resolution

The LCD panel consists of numerous pixels of specified size, which are illuminated to form images. The EIZO S2100-M monitor consists of 1600 horizontal pixels and 1200 vertical pixels. At a resolution of 1600 × 1200, all pixels are illuminated as a full screen (1:1).

sRGB (Standard RGB)

International standard for “color reproduction and color space” among peripheral devices (such as monitors, printers, digital cameras, scanners). sRGB allows Internet users to closely match colors as a simple color matching means for the Internet use.

Temperature

Color temperature is a method to measure the white color tone, generally indicated in degrees Kelvin. The screen becomes reddish at a low temperature, and bluish at a high temperature, like the flame temperature.

5000K: Slightly reddish white

6500K: Warm white like paper white

9300K: Slightly bluish white

TMD5 (Transition Minimized Differential Signaling)

A signal transmission system for digital interface.

5-5 Preset Timing

The following table shows factory preset video timing.

Mode	Dot clock		Frequency		Polarity
			Horizontal: kHz	Vertical: Hz	
VGA 640×480@60Hz	25.2 MHz	Horizontal	31.47	Negative	
		Vertical	59.94	Negative	
VGA 720×400@70Hz	28.3 MHz	Horizontal	31.47	Negative	
		Vertical	70.09	Positive	
Macintosh 640×480@67Hz	30.2 MHz	Horizontal	35	Negative	
		Vertical	66.67	Negative	
Macintosh 832×624@75Hz	57.3 MHz	Horizontal	49.73	Negative	
		Vertical	74.55	Negative	
Macintosh 1152×870@75Hz	100.0 MHz	Horizontal	68.68	Negative	
		Vertical	75.06	Negative	
Macintosh 1280×960@75Hz	126.2 MHz	Horizontal	74.76	Positive	
		Vertical	74.76	Positive	
PC-9801 640×400@56Hz	21.0MHz	Horizontal	24.83	Negative	
		Vertical	56.42	Negative	
PC-9821 640×400@70Hz	25.2 MHz	Horizontal	31.5	Negative	
		Vertical	70.15	Negative	
VESA 640×480@72Hz	31.5 MHz	Horizontal	37.86	Negative	
		Vertical	72.81	Negative	
VESA 640×480@75Hz	31.5 MHz	Horizontal	37.5	Negative	
		Vertical	75	Negative	
VESA 800×600@56Hz	36.0 MHz	Horizontal	35.16	Positive	
		Vertical	56.25	Positive	
VESA 800×600@60Hz	40.0 MHz	Horizontal	37.88	Positive	
		Vertical	60.32	Positive	
VESA 800×600@72Hz	50.0 MHz	Horizontal	48.08	Positive	
		Vertical	72.19	Positive	
VESA 800×600@75Hz	49.5 MHz	Horizontal	46.88	Positive	
		Vertical	75	Positive	
VESA 1024×768@60Hz	65.0 MHz	Horizontal	48.36	Negative	
		Vertical	60	Negative	
VESA 1024×768@70Hz	75.0 MHz	Horizontal	56.48	Negative	
		Vertical	70.07	Negative	
VESA 1024×768@75Hz	78.8 MHz	Horizontal	60.02	Positive	
		Vertical	75.03	Positive	
VESA 1152×864@75Hz	108.0 MHz	Horizontal	67.5	Positive	
		Vertical	75	Positive	
VESA 1280×960@60Hz	108.0 MHz	Horizontal	60	Positive	
		Vertical	60	Positive	
VESA 1280×1024@60Hz	108.0 MHz	Horizontal	63.98	Positive	
		Vertical	60.02	Positive	
VESA 1280×1024@75Hz	135.0 MHz	Horizontal	79.98	Positive	
		Vertical	75.03	Positive	
VESA 1600×1200@60Hz	162.0 MHz	Horizontal	75	Positive	
		Vertical	60	Positive	

Attention

- Display position may be deviated depending on the PC connected, which may require screen adjustment using Adjustment menu.
- If a signal other than those listed in the table is input, adjust the screen using the Adjustment menu. However, screen display may still be incorrect even after the adjustment.
- When interlace signals are used, the screen cannot be displayed correctly even after screen adjustment using the Adjustment menu.



Congratulations!

The display you have just purchased carries the TCO'03 Displays label. This means that your display is designed, manufactured and tested according to some of the strictest quality and environmental requirements in the world. This makes for a high performance product, designed with the user in focus that also minimizes the Impact on our natural environment.

Some of the features of the TCO'03 Display requirements:

Ergonomics

- Good visual ergonomics and image quality in order to improve the working environment for the user and to reduce sight and strain problems. Important parameters are luminance, contrast, resolution, reflectance, colour rendition and image stability.

Energy

- Energy-saving mode after a certain time - beneficial both for the user and environment
- Electrical safety

Emissions

- Electromagnetic fields
- Noise emissions

Ecology

- The products must be prepared for recycling and the manufacturer must have a certified environmental management system such as EMAS or ISO 14000
- Restrictions on
 - chlorinated and brominated flame retardants and polymers
 - heavy metals such as cadmium, mercury and lead.

The requirements included in this label have been developed by TCO Development in co-operation with scientists, experts, users as well as manufacturers all over the world. Since the end of the 1980s TCO has been involved in influencing the development of IT equipment in a more user-friendly direction. Our labeling system with displays in 1992 and is now requested by users and IT-manufacturers all over the world.

**For more information, please visit
www.tcodevelopment.com**

For U.S.A. , Canada, etc. (rated 100-120 Vac) Only

FCC Declaration of Conformity

We, the Responsible Party

EIZO NANAOTECHNOLOGIES INC.

5710 Warland Drive, Cypress, CA 90630

Phone: (562) 431-5011

declare that the product

Trade name: EIZO

Model: FlexScan S2100-M

is in conformity with Part 15 of the FCC Rules. Operation of this product is subject to the following two conditions: (1) this device may not cause harmful interference, and (2) this device must accept any interference received, including interference that may cause undesired operation.

This equipment has been tested and found to comply with the limits for a Class B digital device, pursuant to Part 15 of the FCC Rules. These limits are designed to provide reasonable protection against harmful interference in a residential installation. This equipment generates, uses, and can radiate radio frequency energy and, if not installed and used in accordance with the instructions, may cause harmful interference to radio communications. However, there is no guarantee that interference will not occur in a particular installation. If this equipment does cause harmful interference to radio or television reception, which can be determined by turning the equipment off and on, the user is encouraged to try to correct the interference by one or more of the following measures.

- * Reorient or relocate the receiving antenna.
- * Increase the separation between the equipment and receiver.
- * Connect the equipment into an outlet on a circuit different from that to which the receiver is connected.
- * Consult the dealer or an experienced radio/TV technician for help.

Changes or modifications not expressly approved by the party responsible for compliance could void the user's authority to operate the equipment.

Note

Use the attached specified cable below or EIZO signal cable with this monitor so as to keep interference within the limits of a Class B digital device.

- AC Cord
- Shielded Signal Cable (D-SUB mini 15 pin - D-SUB mini 15 pin, the enclosed signal cable)
- Stereo mini-jack cable

Canadian Notice

This Class B digital apparatus complies with Canadian ICES-003.

Cet appareil numérique de la classe B est conforme à la norme NMB-003 du Canada.

Hinweise zur Auswahl des richtigen Schwenkarms für Ihren Monitor

Dieser Monitor ist für Bildschirmarbeitsplätze vorgesehen. Wenn nicht der zum Standardzubehör gehörige Schwenkarm verwendet wird, muss statt dessen ein geeigneter anderer Schwenkarm installiert werden. Bei der Auswahl des Schwenkarms sind die nachstehenden Hinweise zu berücksichtigen:

Der Standfuß muß den nachfolgenden Anforderungen entsprechen:

- a) Der Standfuß muß eine ausreichende mechanische Stabilität zur Aufnahme des Gewichtes vom Bildschirmgerät und des spezifizierten Zubehörs besitzen. Das Gewicht des Bildschirmgerätes und des Zubehörs sind in der zugehörigen Bedienungsanleitung angegeben.
- b) Die Befestigung des Standfusses muß derart erfolgen, daß die oberste Zeile der Bildschirmanzeige nicht höher als die Augenhöhe eines Benutzers in sitzender Position ist.
- c) Im Fall eines stehenden Benutzers muß die Befestigung des Bildschirmgerätes derart erfolgen, daß die Höhe der Bildschirmmitte über dem Boden zwischen 135 – 150 cm beträgt.
- d) Der Standfuß muß die Möglichkeit zur Neigung des Bildschirmgerätes besitzen (max. vorwärts: 5°, min. nach hinten $\geq 5^\circ$).
- e) Der Standfuß muß die Möglichkeit zur Drehung des Bildschirmgerätes besitzen (max. $\pm 180^\circ$). Der maximale Kraftaufwand dafür muß weniger als 100 N betragen.
- f) Der Standfuß muß in der Stellung verharren, in die er manuell bewegt wurde.
- g) Der Glanzgrad des Standfusses muß weniger als 20 Glanzeinheiten betragen (seidenmatt).
- h) Der Standfuß mit Bildschirmgerät muß bei einer Neigung von bis zu 10° aus der normalen aufrechten Position kippstabil sein.

Hinweis zur Ergonomie :

Dieser Monitor erfüllt die Anforderungen an die Ergonomie nach EK1-ITB2000 mit dem Videosignal, 1600 × 1200 RGB analog, 0,7 Vp-p und mindestens 60,0 Hz Bildwiederholfrequenz, non interlaced. Weiterhin wird aus ergonomischen Gründen empfohlen, die Grundfarbe Blau nicht auf dunklem Untergrund zu verwenden (schlechte Erkennbarkeit, Augenbelastung bei zu geringem Zeichenkontrast.)

„Maschinenlärminformations-Verordnung 3. GPSGV:

Der höchste Schalldruckpegel beträgt 70 dB(A) oder weniger gemäss EN ISO 7779“

Recycle Auskunft

Die Rücknahme dieses Produktes nach Nutzungsende übernimmt EIZO in Deutschland zusammen mit dem Partner eds-r gmbh rucknahmesysteme. Dort werden die Geräte in ihre Bestandteile zerlegt, die dann der Wiederverwertung zugeführt werden. Um einen Abholtermin zu vereinbaren und die aktuellen Kosten zu erfahren, benutzen Sie bitte folgende Rufnummer: 02153-73 35 00. Weitere Informationen finden Sie auch unter der Internet-Adresse: www.eizo.de.

Recycling Information for customers in Switzerland:

All recycling information is placed in the SWICO's website.
<http://www.swico.ch>

Recycling-Information für Kunden in der Schweiz:

Alle Informationen zum Thema Recycling finden Sie auf der Homepage des Branchenverbandes SWICO.
<http://www.swico.ch>

Renseignements de recyclage pour les clients en Suisse:

Vous trouvez tous les renseignements pour le sujet de recyclage sur la page WEB de l'UNION DE BRAN CHE SWICO.
<http://www.swico.ch>

Recycling Information for customers in USA:

All recycling information is placed in the EIZO Nanao Technologies, Inc's website.
<http://www.eizo.com>

Återvinnings information för kunder i Sverige:

All information om återvinning finns på Eizo Europe AB:s hemsida:
www.eizo.se



EIZO NANA O CORPORATION

153 Shimokashiwano, Hakusan, Ishikawa 924-8566 Japan
Phone: +81 76 277 6792 Fax: +81 76 277 6793

EIZO NANA O TECHNOLOGIES INC.

5710 Warland Drive, Cypress, CA 90630, U.S.A.
Phone: +1 562 431 5011 Fax: +1 562 431 4811

EIZO EUROPE AB

Lovangsvagen 14 194 61, Upplands Väsby, Sweden
Phone: +46 8 590 80 000 Fax: +46 8 590 91 575

EIZO NANA O AG

Moosacherstrasse 6, Au CH - 8820 Wadenswil, Switzerland
Phone: +41-0-44 782 24 40 Fax: +41-0-44 782 24 50

Avnet Technology Solutions GmbH

Lötscher Weg 66, D-41334 Nettetal, Germany
Phone: +49 2153 733-400 Fax: +49 2153 733-483

1st Edition-October, 2005

<http://www.eizo.com/>